



## WHYNTER 11,000 BTU DUAL HOSE PORTABLE AIR CONDITIONER

MODEL# : ARC-110WD

### Instruction Manual



Congratulations on your new WHYNTER product. To ensure proper operation, please read this Instruction Manual carefully before using this product. Keep this manual in a safe place for future reference.

# **TABLE OF CONTENTS**

---

INTRODUCTION	3
SAFETY PRECAUTIONS	4-5
IDENTIFICATION OF ACCESSORIES	6
IDENTIFICATION OF PARTS	7
INSTALLATION INSTRUCTIONS	8-9
AIR FILTERS INSTALLATION	10
REMOTE CONTROL	11
OPERATION INSTRUCTIONS	11-14
WATER DRAINAGE	14
CARE AND MAINTENANCE	15
TECHNICAL DATA	16
TROUBLESHOOTING	17-18

Thank you for choosing the Whynter portable air conditioner. Please follow the instructions provided in this user guide to obtain the very best performance from your portable air conditioner and take full advantage of the many features your portable air conditioner offers you. We trust that your Whynter air conditioner will provide the performance and reliability that we stand for.

Please keep this user manual in a safe place for future reference.

## ***DISPOSAL***

---



This symbol on the product or its packaging indicates that the appliance cannot be treated as normal domestic trash, but must be handed in at a collection point for recycling electric and electronic appliances. Your contribution to the correct disposal of this product protects the environment. Further information about the recycling of this product can be obtained from your local municipal authority.

**Your safety and the safety of others are very important to us.**

To reduce the risk of fire, electrical shock or injury when using your appliance, follow these basic precautions.

## SAFETY PRECAUTIONS



Before the portable air conditioner is used, it must be properly positioned and installed as detailed in this manual.



- Do not under any circumstances cut or remove the third (ground) prong from the power cord.
- Make sure this unit is connected to a correctly grounded power supply outlet. Do not use an extension cord or power strip.
- The power cord is UL listed. It has a built-in L.C.D.I. (leakage, current, detection, interruption) circuit breaker for added safety. If the power supply is interrupted, press the reset button to reconnect the unit to power source.
- It is recommended to use a separate circuit that its size should be 15 Amps for the air conditioner.
- Do not use an excessively wet cloth, industrial solvents, oil-based products to clean this portable air conditioner.
- To avoid the risk of shock, the product should never be used in bathrooms, shower rooms, or in any other steamy or wet areas.
- Do not store or use gasoline or other flammable vapors and liquids in the vicinity of this or any other appliances.
- Do not repair, disassemble and/or modify the unit by yourself.
- Always turn off the portable air conditioner when cleaning the air filter, and transporting.
- Do not turn this unit on and off by plugging and unplugging. Always use the ON/OFF switch.



- Transport the unit in an upright position only, or leave it in an upright position for at least 2 hours before first use.
- Ensure curtains or other objects are not obstructing the air inlet filters.
- Do not bend or crush the exhaust hose while in use.
- Always allow at least 20" of clearance around the unit for ventilation. Do not use this unit inside closets, cabinets and/or cramped spaces between furniture.
- This unit is optimized to operate in an ambient temperature of 64°F – 95°F.
- This unit must be installed in an area protected from the element, such as wind, rain, water spray or drips.
- The unit should not be located next to ovens, grills or other sources of high heat.
- Always place the unit on even and hard and level surface.
- Do not sit or place objects on the unit.
- Do not allow children to climb, stand or hang on the unit. The air conditioner could tip over and get damaged and/or seriously injure somebody.

- Keep fingers out of the air intakes and air outlets.
- The unit is an electrical appliance. To avoid injury from electrical shock do not operate it with wet hands, while standing on a wet surface or while standing in water. Do not use it in outdoors or in wet conditions.
- When positioning or moving the unit, ensure it is not turned upside down or greater than 45° or more off level.
- This unit is designed for household, non-commercial use only. Any other use will void the warranty.
- Do not plug into the power outlet before set up is completed.
- Do not operate this unit without the air filter(s).
- Do not use harsh chemicals to clean the filter(s). Dry thoroughly before inserting the filter(s) into the unit.
- Do not add extra length to the exhaust hose by more than a total length of 9'. This will reduce the cooling efficiency of the portable air conditioner.
- At the end of each season, all water must be drained from the unit and filter(s) must be cleaned before storage.

THE MANUFACTURER DISCLAIMS ANY RESPONSIBILITY IF THE ABOVE INSTRUCTIONS ARE NOT FOLLOWED.

## OPERATING CONDITION



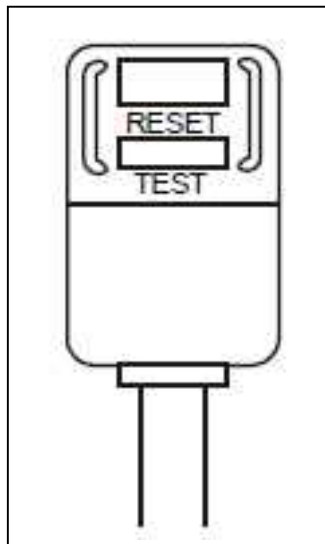





MODE	ROOM TEMPERATURE
COOL	Higher than 66°F
DRY	Higher than 60°F



Your portable air conditioner is supplied with a Leakage-Current Detection and Interruption (LCDI) plug. This plug reduces the risk of fire due to arcing faults in the power supply cord. Please follow the instructions below to ensure that LCDI plug works properly.

1. Plug the power cord to a grounded wall outlet. Do not plug to a power strip or extension cord.
2. Press the TEST button on the plug. This should trip the plug and cut the power to the air conditioner. If the plug does not trip and the unit comes on, please contact technical support.
3. Press the RESET button to start the air conditioner.
4. Do NOT use the TEST and RESET buttons to turn the air conditioner on and off.

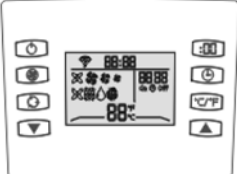
## IDENTIFICATION OF ACCESSORIES

IMAGE	ACCESSORY NAME and DESCRIPTION	QUANTITY
	Small Hose for Exhaust Large Hose for Intake	2 pieces
	Fixture	2 pieces
	Screws	8 pieces
	Hose connectors 2 curved connectors are for large hose 2 straight connectors are for small hose	4 pieces
	Window slider kit	1 set
	Cover	2 pieces
	Remote control	1 piece
	Optional Intake pre-filter (sold separately)	1 piece

## IDENTIFICATION OF PARTS

### Front

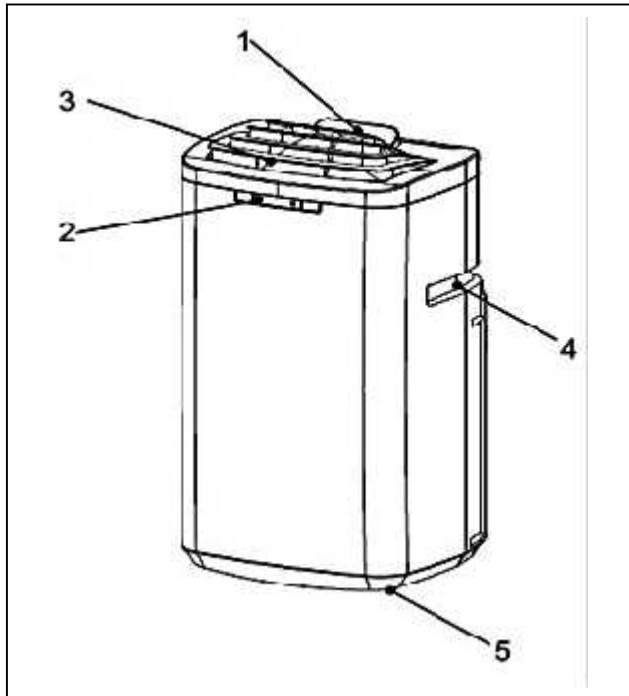

1. Remote control
2. Front display
3. Air outlet
4. Handle
5. Wheels

### Rear

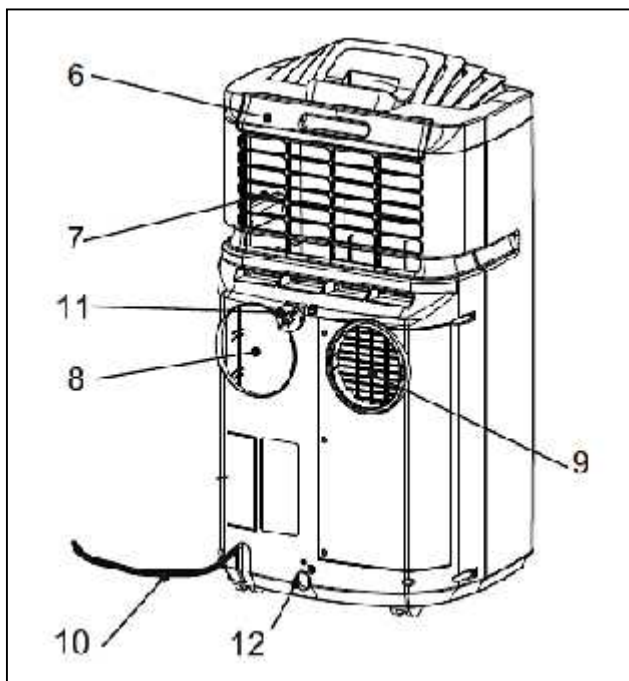

6. Air filter
7. Air intake (evaporator)
8. Air exhaust (for small hose)
9. Air intake (for large hose)
10. Power cord
11. Upper drain port
12. Lower drain port

# INSTALLATION INSTRUCTIONS

## Location

The air conditioner should be placed on a hard and level surface strong enough to support the unit. The unit has casters and it should only be rolled on smooth, flat surfaces. Use caution when rolling on carpet surfaces. Do not attempt to roll the unit over objects.

Never place any obstacles around the air inlet or outlet and allow at least 20 inch of clearance for efficient air-conditioning.

## Exhaust hose Installation

When you use this air conditioner unit, hot air must be exhausted out of the room to complete the air exchange of the condenser. When the unit is operating in DEHUMIDIFYING or FAN only mode, no exhaust is required.

1. Pull out about 6" of one end of the hoses.
2. Attach the 2 straight connectors to the small hose (exhaust) by turning counter-clockwise.
3. Attach the 2 curved neck connectors to the large exhaust hose (intake) by turning clockwise.
4. Align the slots on the hose connector to the tabs on the air intake / outlet and snap the hose to the unit.

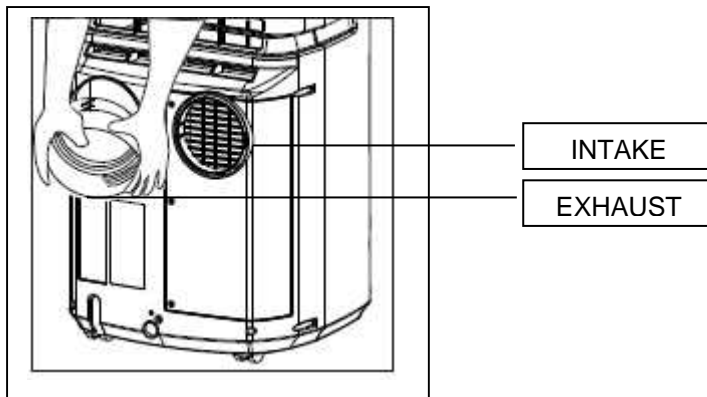

5. Only extend the exhaust hoses to the necessary length. We do not recommend extending the exhaust hose more than 9' long. Additional 4' exhaust hose sold separately.
  6. An optional intake pre-filter can be purchased to be added to the intake hose in locations with poor air quality.
- \* If you are interested in purchasing optional accessories, please contact [info@whynter.com](mailto:info@whynter.com) for retail sales information.



## Window kit Installation

When you use this air conditioner unit, hot air must be exhausted out of the room to complete the air exchange of the condenser. When the unit is operating in dehumidifying and fan-only mode, no exhaust is required.

Your window kit has been designed to fit most standard vertical and horizontal windows. However, it may be necessary for you to modify the installation procedures for your window.

**NOTE:** If your window opening is less than the mentioned minimum length of the window slider kit, cut the slide bar with hole to fit window opening. Never cut out the hole on the window slide bar.

**NOTE:** When using the window kit on a window or sliding door it will cause the window or sliding door not to be properly closed and locked. Additional security measurements may be needed.

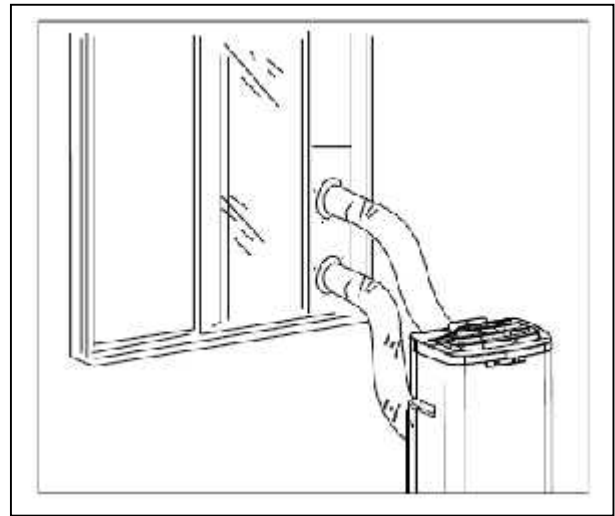
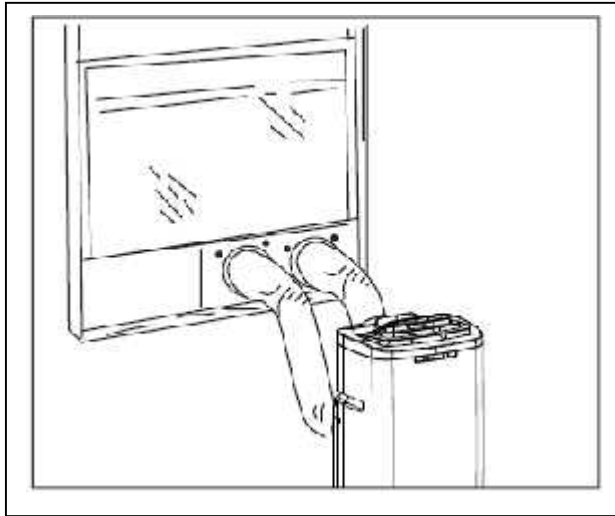

1. Open window approximately 5”.
2. Adjust the length of the window bars to the same length and width of the opening of the window. Cut the window piece if necessary to fit the length of your window.
3. Insert the fixtures through the back grooved side of the window slide bar with holes. Line up the 4 holes and tighten the fixtures with 4 screws from the front. Fig 1.
4. Close the window on the window slide bars. For long term installation, you may screw the window kit into your window frame.
5. Move the unit to the window, extend the hoses and attach the other end of the hoses to the window slide bar.
6. Align the slots on the hose connectors to the tabs on the fixtures and snap the hoses to the window slide bar.

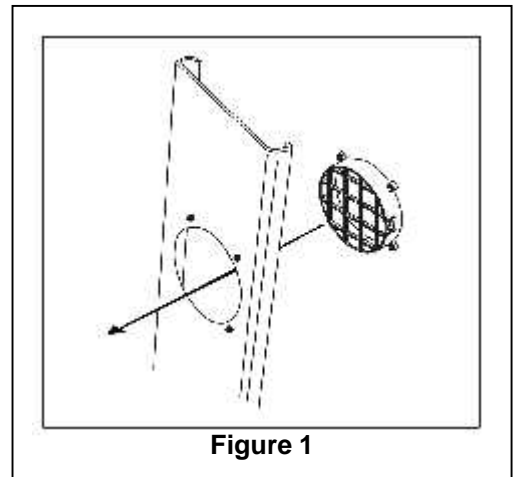

Figure 1

## AIR FILTERS INSTALLATION

Your Whynter portable air conditioner is equipped with a washable Pre-Filter and an activated carbon filter.

The washable Pre-Filter removes large particles such as dust, pet hair and dander.

The activated carbon filter is designed to remove smoke and other odors. It is recommended to replace the activated carbon filter every 2-3 months. Follow the steps below to install the filters.

### **WARNING: NEVER OPERATE THE AIR CONDITIONER WITHOUT THE PRE-FILTER**

1. Pull up the pre-filter frame and remove from the unit.

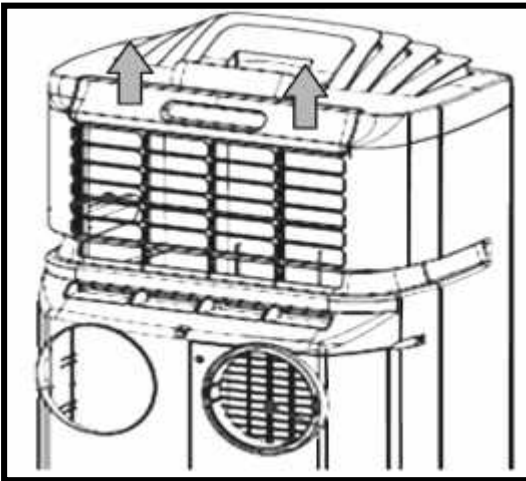

2. Place the activated carbon filter on the pre-filter frame by inserting it through the three pins.

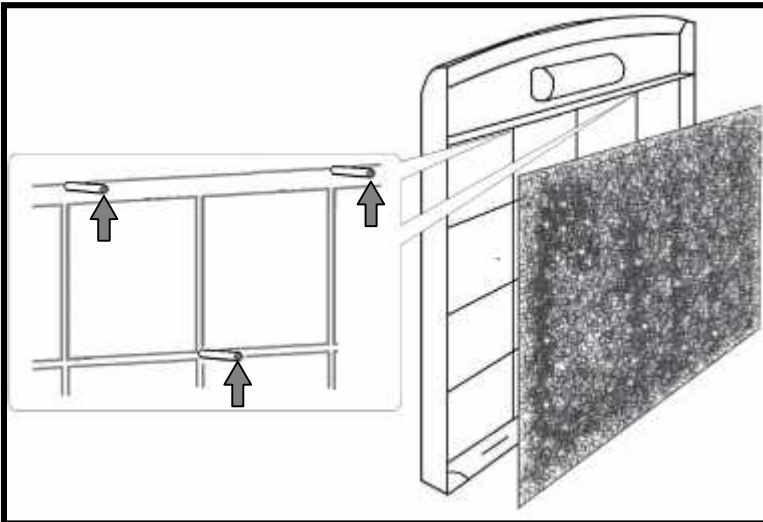

3. Once the activated carbon filter is secured, insert the assembled filter frame into the unit.

# OPERATION INSTRUCTIONS







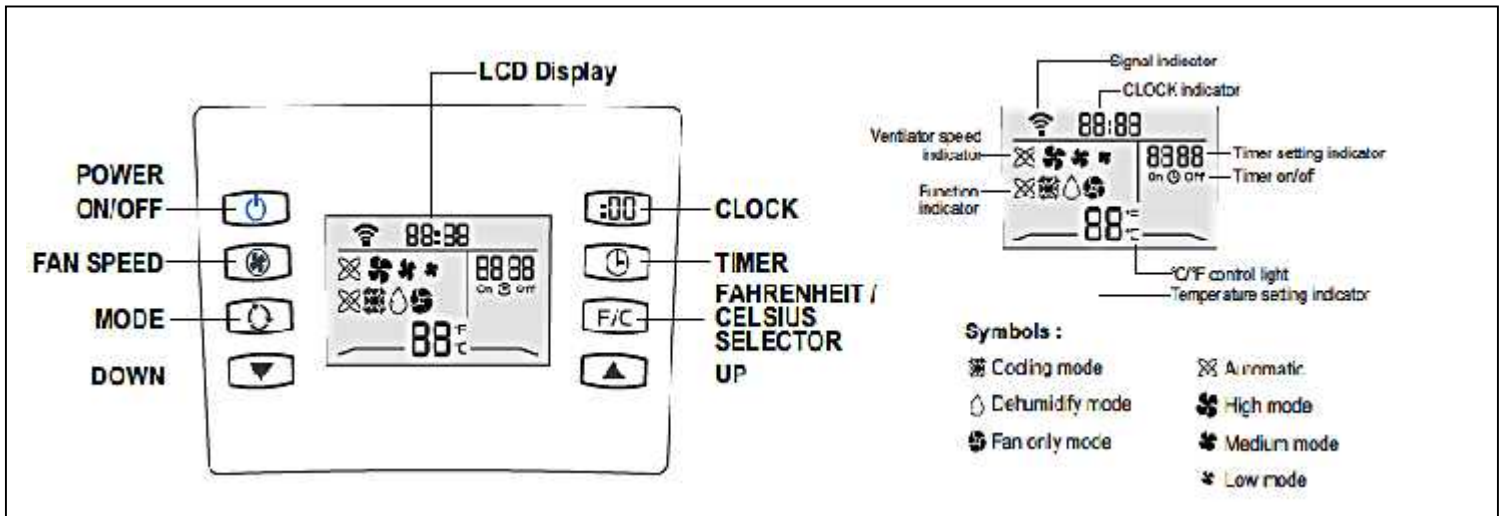

Before you begin, thoroughly familiarize yourself with the control panel of the remote control. Follow the symbol for the desired function. The functions of the unit can be controlled by the remote control only. When using the remote control, make sure the reception of the signal is confirmed by a beep.

**NOTE:**

- Other appliances in the same room controlled by a remote control (TV, radio, stereo, etc.), may cause interferences.
- Electronic and fluorescent lamps may interfere with the signal transmissions between the remote control and the air conditioner.
- Remove the batteries if the remote control is not used for long periods.

## REMOTE CONTROL PANEL



<p><b>Power Control</b> </p> <p>Turns the unit on and off.</p>	<p><b>Timer / Temperature Set Control</b></p> <p>The set temperature can be set between 61°F (16 °C) and 89°F (32°C) by pressing the ▲ and ▼ buttons in cooling mode only.</p>
<p><b>Fan Speed Control</b> </p> <p>Controls the 4 fan speeds: Auto, High, Medium &amp; Low. NOTE: Unit does not need to be vented in Fan mode.</p>	<p><b>Clock</b> </p> <p>Sets the current time.</p>
<p><b>Mode Control</b> </p> <p>Controls the 4 function modes: COOL , DEHUMIDIFY , FAN ONLY  and AUTOMATIC </p>	<p><b>Timer</b> </p> <p>Turns the timer function on and off.</p>
	<p><b>Fahrenheit / Celsius Selector</b></p> <p>Changes the display temperature from Fahrenheit to Celsius and vice versa.</p>

## FRONT PANEL

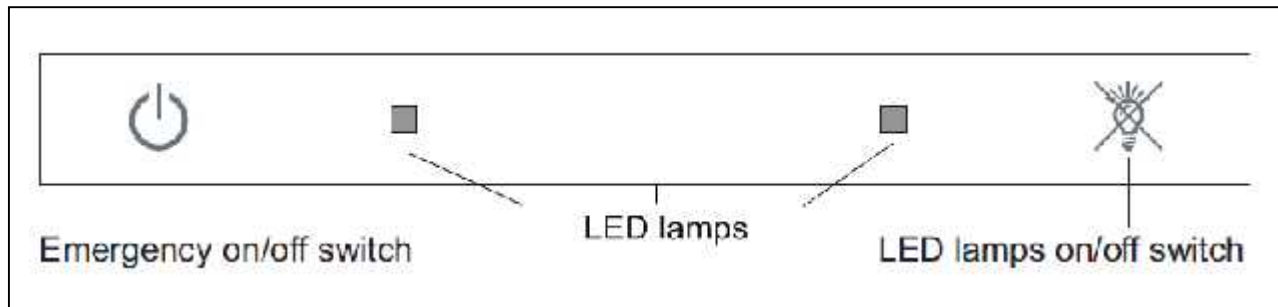

### SWITCHING ON/OFF THE AIR CONDITIONER

- The unit can be switched ON or OFF by pressing the Emergency on/off switch button  on the front display panel or the remote control.  
NOTE: The functions of the portable air conditioner can be switched on by the remote control ONLY. Without using the remote control, the unit can only be switched on at the previous setting and turn off the unit.

### LED LAMPS ON/OFF SWITCH

- Press the LED lamps on/off switch to turn on and off the LED lamps indicators.



### WARNING LIGHT

- When the internal water reservoir is full, the red light will flash and the unit will stop. Remove the drain plug to drain out the water and the unit will restart at the previous setting.

### **BEFORE USING YOUR PORTABLE AIR CONDITIONER**

- Remove the exterior and interior packaging.
- Before connecting the unit to the power source, let it stand upright for approximately 4 hours. This will reduce the possibility of a malfunction in the cooling system from handling during transportation.

### COOLING MODE

- In this mode, the air conditioner cools and dehumidifies the room. To activate this function mode, press the Mode Control button until the  indicator comes on. When the cooling mode is set, the blue light on the front panel comes on and the compressor will start in approximately 3 minutes.  
**NOTE:** In cooling mode, hot air is exhausted from the outdoor exhaust port and the exhaust hose must be connected to exhaust out the hot air.
- The temperature setting range of this air conditioner is from 61°F to 89°F. To set the temperature, press the  or  buttons. This air conditioner has a 5°F temperature cushion which if the set temperature is within 5°F of the ambient temperature, the unit runs on fan only mode. This saves energy and prolongs the life of the compressor of the air conditioner. Once the set temperature is achieved, the fan runs continuously.
- To set the fan speed, press the Fan Speed button. **In cooling mode, the difference in noise level between the fan speeds is not very noticeable when the compressor is on.** Try setting the unit to Fan only mode, you should be able to hear the difference between high and low fan speed settings.

## DEHUMIDIFYING MODE

- In this mode, the air conditioner only dehumidifies the room, the compressor will activate intermittently depending on the ambient temperature. To activate this function mode, press the Mode Control button until the  indicator comes on. When the dehumidifying mode is set, the orange light on the front panel comes on.
- Please note that when switching function mode, there will be an approximately 3 minute transition time. In dehumidifying mode, do not connect the exhaust hose and let the warm air return to the room. If room temperature is higher than 77°F, the fan speed can be adjusted. If room temperature is lower than 77°F, the fan speed is set at Low.

**NOTE:** When using the Dehumidifying mode, the air exhaust hose should not be vented to the outside. If the warm air is exhausted to the outside, cooling may occur. Additionally, you must manually drain the water from the unit.

**Remove the upper drain stopper to setup continuous drainage if needed.** Water can be drained to a container or to a floor drain using a garden hose (not included.)

## FAN ONLY MODE

- In this mode, only the fan of the air conditioner runs and circulates the air in the room. To activate this function mode, press the Mode Control button until the  indicator comes on. When the fan only mode is set, the green light on the front panel comes on.
- In this function mode, the temperature cannot be set. Subsequently, set the desired fan speed by pressing the Fan Speed button. Fan Only mode requires that the exhaust hose be removed.

**NOTE:** The unit does not need to be vented in Fan Only mode.

## AUTOMATIC MODE



- When you set the air conditioner in AUTOMATIC mode, it will automatically select cooling or fan only operation to 85F depending on the ambient temperature. The fan speed is automatically selected and cannot be changed and the temperature cannot be set.
- To activate this function mode, press the Mode Control button until the  indicator comes on. When the automatic mode is set, the light on the front panel displays the color of the mode that the unit is currently operating in.

**NOTE:** In cooling mode, hot air is exhausted from the outdoor exhaust port and the exhaust hose must be connected to exhaust out the hot air.

## FAN SPEED CONTROL

- To set the fan speed, press the fan speed control  button. Fan speed can be set at Automatic, High, Medium and Low.



## CLOCK

- To set the clock, press and hold the clock button  for 3 seconds. Press the up or down buttons to set the current time. To save the current time, press and hold the clock button  again for 3 seconds.

## TIMER (DELAYED SWITCH ON / OFF) FUNCTION



- This function mode enables a delayed switch ON or delayed switch OFF of the air conditioner. The time (hours) delay can be set, enabled and disabled. The timer is adjustable between 1-24 hours.

## SETTING SWITCH OFF TIMER

With the air conditioner operating in any function mode, press the Timer Control button . Then the  Off and the two digits timer indicator will come on. Set the desired time delay OFF hours (1 – 24 hours) by pressing the up or down buttons. When the delay time set has elapsed, the air conditioner will switch off.

To cancel the switch off timer, press the Timer Control button  and set the hour to 00.

## SETTING DELAYED SWITCH ON TIMER

When the air conditioner is off, press the Timer Control button . Then the On  and the two digits timer indicator will come on. Set the desired time delay ON hours (1 – 24 hours) by pressing the up or down buttons. When the delay time set has elapsed, the air conditioner will switch on **in the previous setting**.

To cancel the switch on timer, press the Timer Control button  and set the hour to 00.

## AUTO RESTART

In the event of a power outage, the air conditioner restarts at the previously set function mode and settings when power is restored.

## NOISE LEVEL

Portable air conditioners may make sounds that are not familiar to you. The sounds listed below are normal. Noise reflecting off hard surfaces such as a floor or wall can make the sounds seem louder than they actually are.

- The compressor may make a pulsating or high-pitched sound.
- Water running from the evaporator to the water tank may make a splashing sound.
- Refrigerant flowing may make a gurgling sound.
- Fan sound may come from front and back air vents.

## WATER DRAINAGE

During the process of cooling, some water will be extracted from the air into the unit. Most of this water is used to cool and exhausted to the outside. If the unit is operated in high humidity or low temperature environment, water will collect in the reservoir inside the unit. If the reservoir is full, the compressor will stop. To continue the cooling function, please drain the water.

Manual drain:

1. Turn off the unit.
2. Position a flat container or dish under the drain plug.
3. Remove the drain plug and the condensed water will drain out automatically.
4. Once all the condensed water is drained, replace the drain plug into the drain firmly.

Continuous drainage:

In COOL or DRY modes, remove the upper drain plug from the back of the unit and put a container under the drain port to catch the water. Or install the drain water hose and place the open end of the hose to a drain area.

# CARE AND MAINTENANCE

## **IMPORTANT:**

- Switch off the air conditioner and disconnect the plug from the power outlet
- Drain water by removing the drain plug.
- Always transport the air conditioner in an upright position only.

## **CLEANING THE PRE-FILTER**

- To ensure the air intake is filtered properly and to assure that your air conditioner runs efficiently, it is recommended to clean the Pre-filter at least once every two weeks.
- Switch off the air conditioner and pull out the filter frame from the unit.
- Remove the Activated Carbon filter from the Pre-filter.
- Use a vacuum cleaner or tap lightly to remove loose dust and dirt from the Pre-filter. Then rinse it thoroughly under warm or cold running water (no hotter than 100F.)
- Dry thoroughly before re-inserting the filters.
- **NOTE:** The Activated Carbon filter is not washable. It should be replaced every 2-3 months or as needed.

**WARNING!** Never operate the air conditioner without the filter in place.

## **CLEANING THE AIR CONDITIONER**

- Always switch off the air conditioner and disconnect the plug from the power supply outlet before cleaning the air conditioner.
- Use a soft damp cloth to wipe the body of the unit.
- Never use harsh chemicals, oil-based products, detergents, chemically treated cloths or other cleaning solutions. These could possibly damage the body of the air conditioner.

## **END OF SEASON STORAGE**

- Switch off the air conditioner and disconnect the power plug from the power supply outlet before cleaning the air conditioner.
- Clean the air filters.
- Drain the condensed water **COMPLETELY**.
- On a warm day, turn on the Fan only mode for half a day so that the inside can dry out completely.
- Wrapped the power cord and bundle it with the tape.
- Remove the batteries from the remote controller.
- Disconnect the exhaust hose and cover the window / wall hole with the cover.
- It is recommended that the air conditioner be put back into its original carton for storage.
- To avoid damage to the unit, please leave the hose connectors in place or slightly turn, push and gently pull the connectors off.

## TECHNICAL DATA

Model	ARC-110WD
Cooling capacity	11,000 BTU
Power supply	115v/ 60Hz
Maximum power input	1040 Watts
Maximum input	9.5 Amps
Dehumidifying capacity	81 Pts / Day
Thermostat	61°F to 89°F
Refrigerant	R-410A
Air flow (max.)	300 m3/ Hour
Exhaust hose length	47"
Unit Dimensions	17.3" W x 15.4" D x 30.5" H
Package Dimensions	18.7" W x 19.5"D x 35"H
Unit Weight	65 lbs



# TROUBLESHOOTING

Problem	Possible Causes	Solutions
<p>The portable air conditioner does not turn on</p>	<ul style="list-style-type: none"> <li>• Power failure / outage.</li> <li>• The automatic switch, line fuse, or breaker has been tripped.</li> <li>• The power supply voltage is too low.</li> <li>• The power cord is damaged.</li> <li>• The L.C.D.I. power plug for the unit is tripped.</li> <li>• The internal water reservoir is full.</li> <li>• Possible loose connection</li> </ul>	<ul style="list-style-type: none"> <li>• Restore the power supply.</li> <li>• Flip the switch / change the fuse / turn the breaker back on. Also note that you may have too many appliances drawing power on one circuit, you may need to move the other appliances to another circuit.</li> <li>• Move the unit onto another circuit with the correct voltage.</li> <li>• Contact Whynter Service Department. Only authorized personnel should replace damaged power cord or power plug.</li> <li>• Press the Reset button on the L.C.D.I. power plug.</li> <li>• Drain water from the air conditioner.</li> <li>• Contact Service Department</li> </ul>
<p>The unit turns on but the compressor does not turn on (the fan runs but the unit is not cooling)</p>	<ul style="list-style-type: none"> <li>• The room temperature is outside of the operational tolerances of the unit.</li> <li>• The Cooling mode is not on.</li> <li>• The compressor has not turned on yet because of its time delay.</li> <li>• The set temperature is too high.</li> <li>• The internal water reservoir is full.</li> </ul>	<ul style="list-style-type: none"> <li>• This unit is designed to work in ambient temperatures of 64°F to 95°F.</li> <li>• Press the MODE button until the COOL light is shown on the display.</li> <li>• Give the compressor 3 minutes to turn on after the Cooling mode has been selected.</li> <li>• Set the air conditioner to a lower temperature. It is recommended to set the temperature to at least 5°F of the ambient temperature.</li> <li>• Either manually drain the water by removing the drain plug or allow the unit to exhaust the water itself by running the fan only mode. Then cooling will resume.</li> </ul>

<p>The air coming out of the unit is not very cold, or the airflow volume is weak</p>	<ul style="list-style-type: none"> <li>• The filters are dirty or obstructed.</li> <li>• The air intake or exhaust is obstructed.</li>   <li>• The unit is set in DRY or FAN mode.</li> <li>• The unit is set to low fan speed.</li> </ul>	<ul style="list-style-type: none"> <li>• Clean the air filters.</li> <li>• Make sure there is at least 20" of clearance from the air intake. Make the length of the exhaust hose is as short as possible.</li> <li>• Set the unit to the cooling mode.</li> <li>• Set the unit to a higher fan speed.</li> </ul>
<p>The unit has worked for a long time, but the room is not cold enough</p>	<ul style="list-style-type: none"> <li>• Windows or doors are open.</li> <li>• There are too many people in the room.</li> <li>• There is direct sunshine into the room.</li> <li>• The room is a kitchen or with many heat-producing appliances</li> <li>• There is a server in the room.</li> <li>• The room is too large.</li> </ul>	<ul style="list-style-type: none"> <li>• Close all windows and doors.</li> <li>• You may need additional cooling or another air conditioner.</li> <li>• Close curtains or blinds and try to minimize the amount of direct sunlight into the room.</li> <li>• You may need additional cooling or another air conditioner.</li> <li>• You may need additional cooling or another air conditioner.</li> <li>• You may need additional cooling or another air conditioner.</li> </ul>
<p>The unit is very noisy</p>	<ul style="list-style-type: none"> <li>• The unit is not level.</li> <li>• The surface underneath the unit is uneven.</li> <li>• Low power voltage.</li> </ul>	<ul style="list-style-type: none"> <li>• Make sure the unit is on hard, level and stable surface.</li> <li>• Move the unit to a location with a level and hard floor.</li> <li>• Make sure the wall outlet and support the required power consumption of the air conditioner and do not use an extension cord.</li> </ul>
<p>The unit leaks water</p>	<ul style="list-style-type: none"> <li>• The unit is tilted or not leveled</li> <li>• The water tank is full.</li> </ul>	<ul style="list-style-type: none"> <li>• Make use the unit is leveled.</li> <li>• Drain water from the drain plug at the back of the air conditioner.</li> </ul>
<p>The unit needs to be drained too often</p>	<ul style="list-style-type: none"> <li>• The humidity in the area may very high</li> <li>• Possible loose connection</li> </ul>	<ul style="list-style-type: none"> <li>• Remove the intake hose if the outside humidity is high or it is raining</li> <li>• Contact Service Department</li> </ul>
<p>Fan speed cannot be changed</p>	<ul style="list-style-type: none"> <li>• Fan speed differences are not very noticeable</li> </ul>	<ul style="list-style-type: none"> <li>• The fan speed difference is not very noticeable when the compressor is on. Try setting the unit to Fan only mode, you should be able to hear the difference between high and low fan speed settings.</li> </ul>